



CUSTOMIZE YOUR ROLLING TARP TO MEET YOUR REQUIREMENTS

STANDARD FEATURES

AVAILABLE OPTIONS



LOADS LIKE A FLATBED... PROTECTS LIKE A VAN!™



STANDARD FEATURES FOR CHAMELEON ROLLING TARP SYSTEMS



Front Tensioning System

- No tools required.
- Quickly open the tarp system without opening the rear door.
- Accepts winch bar for even greater tensioning.



Scan/Click for Video

Rear Locks w/ Tarp Tensioning Adjustment

- Simplest & quickest locking system on the market.
- No tools required.
- Adjusts tarp tension when required.



Scan/Click for Video



119	123	143	168
221	244	311	323
356	537	543	549
566	590	619	636
679	682	705	717
763	830	905	907
			911

Fade Resistant UV Protected PVC Fabrics

- 20oz (typical) & 40oz+ in wear areas.
- Standard white roof lets light shine in.
- Welded seams (not sewn).
- Many standard colors available.

Dual-Mudguard Sealing Rail System

- Stops road-spray from entering the load volume.
- Flexible rubber (high/low temperature design) seals around straps to keep water out.



STANDARD FEATURES FOR CHAMELEON ROLLING TARP SYSTEMS

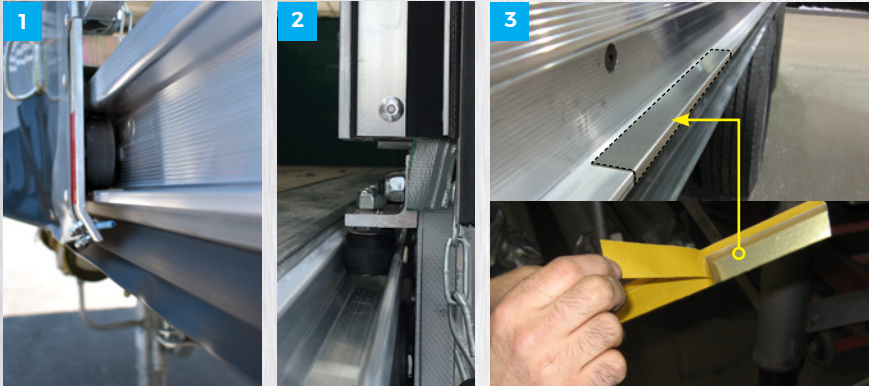

Wheels & Rail System

- Low-friction rails and wheels with sealed stainless steel bearings for low-wear & easy rolling. No greasing needed. (1)
- The small guide wheels ensure easy 1-person operation. (2)
- Stainless replaceable wear strips protect rails against wear. (3)

Easy-to-repair Modular Structure

- Chameleon is continually making its products easier to repair.
- Most of our parts can be shipped overnight to get you back on the road quicker.
- Components are fastened together rather than welded for quicker repair & installation.

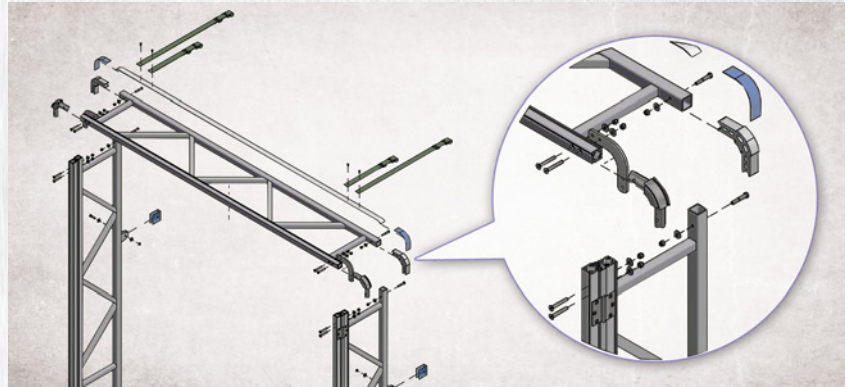

Forklift Railguard

- Protects the rails against forklift collision when loading and unloading.
- Place where you want the forklift to load.

Rear Door Sealing

- Mechanical door clamp system seals/ secures the sides of the door better and is more reliable than velcro/buckle systems.
- 2-Stage sealing system along base of door for tight seal against snow and road spray.
- Ergonomic handle & adjustable door clamp compression adjustment thread.

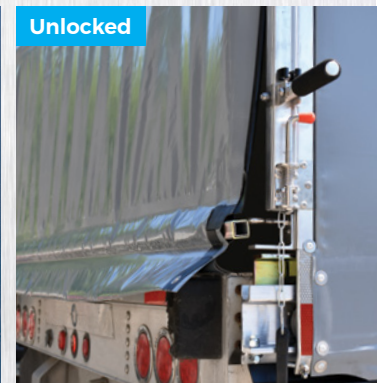

HEADBOARD - STANDARD FEATURES

Choose from the following options at **no extra charge**.

Smooth Mill Finish



Gloss Tread Finish



HEADBOARD FINISHES

HEADBOARD - AVAILABLE OPTIONS

Choose from the following options at an extra charge.

Stainless Steel Headboard



- Mirror-like stainless steel skin on lightweight aluminum structure.

Headboard Wraps



- Customize the front of your Chameleon to match your corporate branding or truck.
- Add color, logos and/or graphics.

Standard Integrated Chain Rack



HEADBOARD ACCESSORIES

Headboard Shelving



Chain Binder Racks



Adjustable Headboard Vents

- Ventilation for food and gas transport.



Exterior

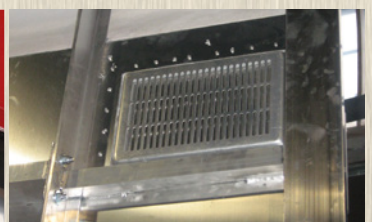

Interior



Exterior

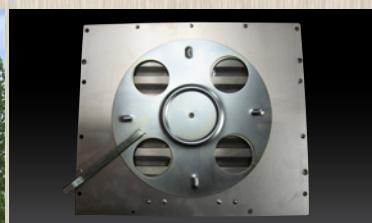

Interior

HEADBOARD - STANDARD FEATURES

Choose from the following options at **no extra** charge.

White Air Deflector

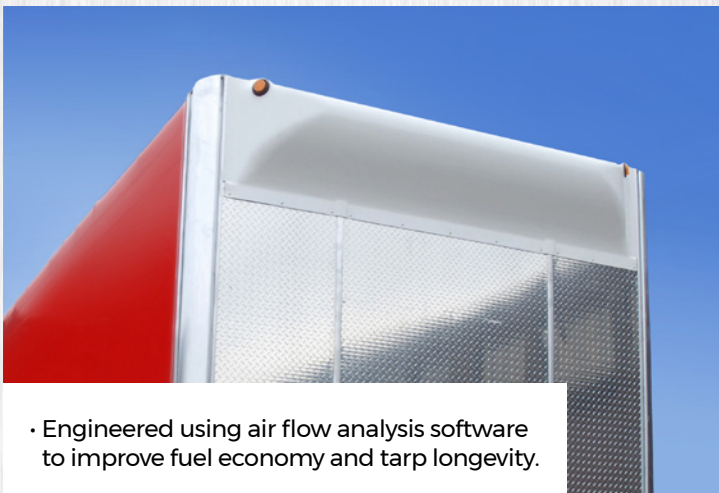

- Engineered using air flow analysis software to improve fuel economy and tarp longevity.

Aluminum Top Plate (Smooth Mill Finish)

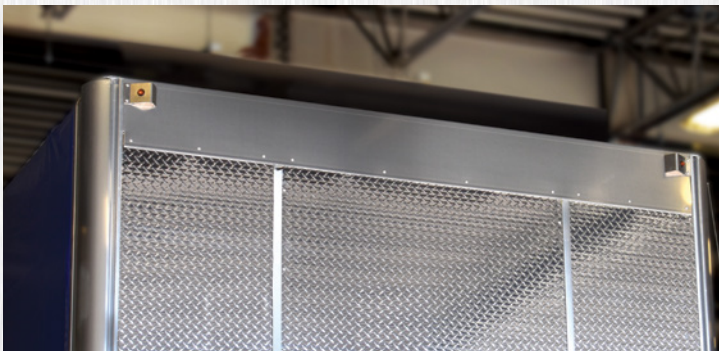

Features 2x LED clearance lights.

HEADBOARD - AVAILABLE OPTIONS

Choose from the following options at an **extra** charge.

Customized Air Deflector

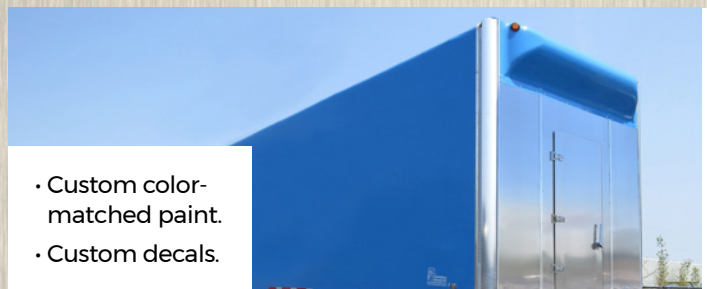

- Custom color-matched paint.
- Custom decals.

Headboard Access Door



- 30" x 60" opening with 3-point locking system.
- Exterior & interior handles.
- Custom sizes available.

Headboard Aerodynamic Kit



- Fuel savings of 2-3%. Pays for itself in approximately 12 months.
- Aerodynamically designed to fill the gap between the tractor and the headboard to shield the negative effects of crosswinds to optimize fuel savings and driving stability.
- Does not interfere with turning radius of tractor. Open design to avoid interference with hook up and headboard access door.

DOT-Rated Headboard



- 58,000 lbs rating; Tested according to 49 CFR 393.114 (C) 2.
- Headboard access door not available on DOT headboards.
- Subject to trailer specification review.

HEADBOARD - STANDARD FEATURES

Choose from the following options at **no extra** charge.

Headboard Standard Lighting

HEADBOARD LIGHTING



- Features 2x LED clearance lights on air deflector or top plate.

HEADBOARD - AVAILABLE OPTIONS

Choose from the following options at an **extra** charge.

Custom Headboard Lighting



- 9X LED Lights.



- 5X LED Lights.



- Emergency & Strobe Shelves.

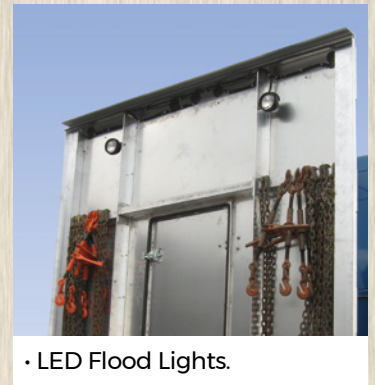

- LED Flood Lights.

Single Lift Bows

LIFT BOW SYSTEM

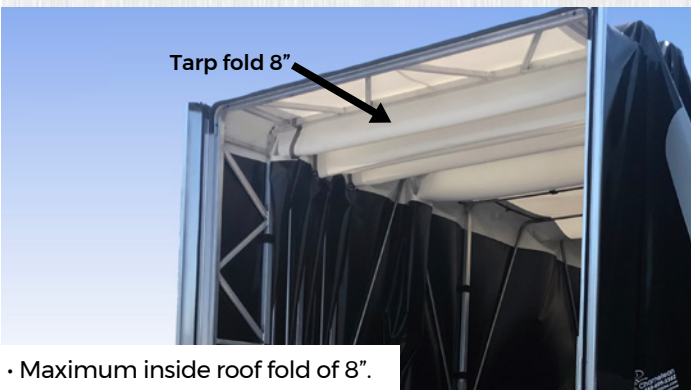

Tarp fold 8"

- Maximum inside roof fold of 8".

Double Lift Bows



Tarp fold 3"

- Decrease roof folds from 8" to 3".
- Highly recommended if you haul high loads.

REAR DOOR SYSTEMS STANDARD FEATURES

Choose from the following options at **no extra** charge.

Rope-Operation



REAR DOOR SYSTEMS AVAILABLE OPTIONS

Choose from the following options at an extra charge.

Rope-Door Lifting Device



- Gas-cylinder powered frame lifts rope operated roll-up door up to clear your high loads.
- Alternative to crank-operated rear door setups to provide more height clearance but without tools.

Van-Style Rear Doors



- Standard in white.
- Color vinyl wraps available.
- Decaling available.
- Stainless Steel.



REAR DOOR SYSTEMS

REAR DOOR SYSTEMS STANDARD FEATURES

Choose from the following options at **no extra** charge.

Crank-Operation



REAR DOOR SYSTEMS AVAILABLE OPTIONS

Choose from the following options at an extra charge.

Hybrid Door Operation



- Provides speed/ convenience of rope-operated door and height clearance of crank-operated door.

Rear Door Extension Kit



- Cover a load that extends past the rear of the deck.
- Approximate 10-12" extension.
- Neatly folds away into the rear bow frame when not in use.



AVAILABLE OPTIONS - GRAPHICS

Choose from the following options at **an extra** charge.

Graphics - Stenciled



- Traditional stencils are painted with a flexible anti-fade ink.
- Most reliable & easy-to-clean.
- Color matching available.
- In-house graphic design services available.



Graphics - Digital



- Less expensive than a billboard and seen by millions.
- Photo quality printing technology.
- Very affordable in-house graphic design services available.



GRAPHICS

AVAILABLE OPTIONS - MAXIMIZE LOAD CAPACITY

Choose from the following options at **an extra** charge.

LIGHTING

Lightbar



- Aluminum enclosure with stainless steel face. ¾" amber LEDs



Rail Extensions



- Allows access to entire length of trailer while loading extra long loads.
- Portable - Disassembles to travel with trailer.
- Leveling legs to adjust to trailer height.



MAXIMIZE LOAD CAPACITY

Roll-Off Stand



- Oversized loads? Roll the tarp system off the deck and store it on a roll-off stand.
- Swivel casters for easy relocation in your shop.
- Leveling legs to adjust to trailer height.



Oversized Heights & Widths



- Inside Height Clearance: Up to 144".
- Inside Width Clearance: Up to 104".
- Chameleon can do even larger heights & widths for special projects.

REQUEST FOR QUOTE FORM

COMPANY: DATE:
 FIRST/LAST NAME:



TRAILER/DECK TYPE

FLATBED TRAILER

DROP DECK TRAILER - Operation Type: Option 1 (Pallet Loads); Option 2 (Full Lower Deck Access); Split at Drop
STRAIGHT TRUCK DECK - If Applicable: On Board Forklift; Overhead Boom; Knuckle Boom; Lift Gate

B-TRAIN FLATBED SEMI-TRAILER

TILT DECK - Type: Flatbed Trailer; Truck/Carrier Deck; Drop Deck Trailer

GOOSE NECK UTILITY TRAILER **BUMPER HITCH UTILITY TRAILER** **LOW-BOY / DETACHABLE GOOSENECK**
OTHER:

TRAILER/DECK LENGTH

These specifications are an estimated average. Weights & retracted lengths will vary slightly according to exact kit sizing and features selected.

- Trailer/Deck Length: -(For A & B-Trains: Specify both trailer lengths)
- 48'-53' (2020lbs & 106" Retracted Length - Note: Drop Deck: 2750lbs & 136" Retracted Length)
 - 41'-48' (1870lbs & 95" Retracted Length - Note: Drop Deck: 2560lbs & 125" Retracted Length)
 - 35'-41' (1720lbs & 84" Retracted Length - Note: Drop Deck: 2360lbs & 114" Retracted Length)
 - 26'-35' (1575lbs & 73" Retracted Length)
 - 18'-26' (1420lbs & 62" Retracted Length)
 - 14'-18' (1270lbs & 51" Retracted Length)
 - 3'-14' (1125lbs & 40" Retracted Length)

INTERIOR WIDTH CLEARANCE REQUIRED

Interior Width Clearance Required:
 • Legal limit is 104" interior width on 102" deck/trailer (Resulting in 108" overall width legal limit)
 • Allowed to add up to 2" of interior width in addition to the trailer width (Ex: 96" Trailer + 2" Additional = 98" Interior Width)

INTERIOR HEIGHT CLEARANCE REQUIRED

Interior Height Clearance Required:
 Price Level 1: 40" - 90" Interior Height (Not applicable to drop decks)
 Price Level 2: 90" - 102" Interior Height (Not applicable to drop decks)
 Price Level 3: Additional 6" Increments (Applicable to drop decks)
 We customize to the nearest 1/2" incremental height, at no extra charge, in order to maximize your load volume

OVERALL HEIGHT LIMIT REQUIRED

13'6"; 14'0"; Other (Example: Your drive-in garage door is lower than 13'6")

STANDARD NO-CHARGE FEATURES

AVAILABLE OPTIONS

HEADBOARD FINISHES

Aluminum Smooth Mill Finish
 Aluminum Gloss Tread Finish

Mirror-like Stainless Steel Skin
 Headboard & Wing Wrap. Color:

HEADBOARD ACCESSORIES

White Air Deflector
 Aluminum Top Plate (Smooth Mill Finish)

- Headboard Shelving
 - ↳ Chain Binder Rack Side Shelves Center Shelf Floor Basket
 - ↳ 2x Door-Style Vents 2x Adjustable Vents
- Adjustable Headboard Vents
- Headboard Access Door (Typically 30" x 60")
- Painted Air Deflector - Color:
- Air Deflector Decals
- Headboard Aerodynamic Kit (2-3% fuel savings)
- DOT-Rated; Access Door Not Available

HEADBOARD LIGHTING

2x Round 3" Amber LED Clearance Lights (On Air Deflector)
 2x 3/4" Amber Marker Lights (On Top Plate)

Additional 3x Amber LED Clearance Lights (5x Total)
 Additional 7x Amber LED Clearance Lights (9x Total)
 2x Interior LED Flood Lights
 Strobe/Emergency Light Shelves (2x)

LIFT BOWS SYSTEM

Single Lift Bows (8" Roof Folds)

Double Lift Bows (3" Roof Folds)

REAR DOOR SYSTEMS

Crank-Operated Roll-up Door
 Rope-Operated Roll-up Door

Van-Style Door White or Color: Decals:
 Door Lifting Device (Rope-Operated Door Only)
 Rear Door Extension Kit
 Hybrid Door System (Rope & Crank Function)

GRAPHICS

No Graphics

Stenciled & Painted
 Digital (Image-based Graphics and/or Gradient Logos)
 Please Quote Chameleon In-House Graphic Design Services

OVERSIZED LOAD CONVENIENCE PACKAGES

Rail Extensions (Portable)
 Roll-Off Stand with Casters (Store system at home)

LIGHTBAR

Lightbar (Both Sides)

TARP COLOR (SIDES & DOOR)

#

- 119
- 123
- 143
- 168
- 221
- 244
- 311
- 323
- 356
- 537
- 543
- 549
- 566
- 590
- 619
- 636
- 679
- 682
- 705
- 717
- 763
- 830
- 905
- 907
- 911

ROOF COLOR

White Translucent Same Color as Tarp Sides



***Chameleon will customize your rolling tarp
to meet your requirements. Challenge us
to provide solutions to your specific needs.***



Scan/Click
for Website

 **OFFICE:** 115 Hymus Boulevard,
Pointe-Claire, QC, Canada H9R 1E5

 **TOLL-FREE:** 1 888.695.3382

 **INTERNATIONAL:** (514) 695.3382

 **FAX:** (514) 630.7266

 **EMAIL:** info@chameleon.ca

 **www.rollingtarps.com / www.chameleon.ca**